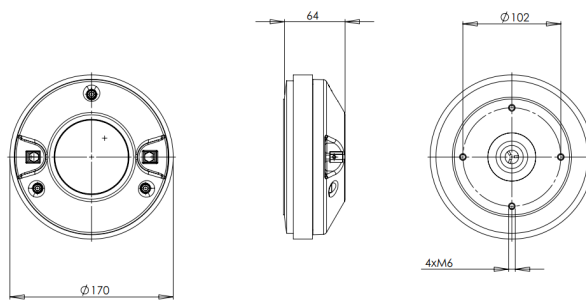

DE85TN

8Ω**HF Drivers - 2.0 Inches**

- 220 W continuous program power capacity
- 2" horn throat diameter
- 75 mm (3 in) aluminium voice coil
- Titanium diaphragm
- 500 - 18000 Hz response
- 107 dB sensitivity
- Shorting copper cap for extended HF response

DE85TN

HF Drivers- 2.0 Inches

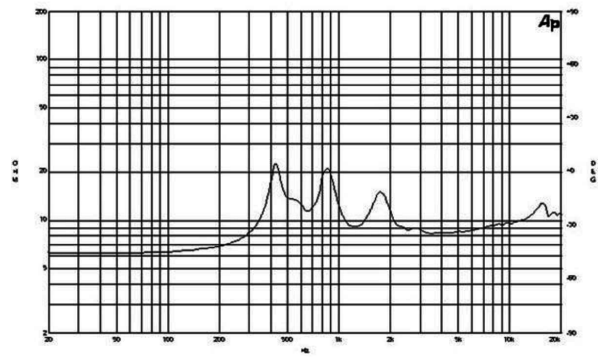
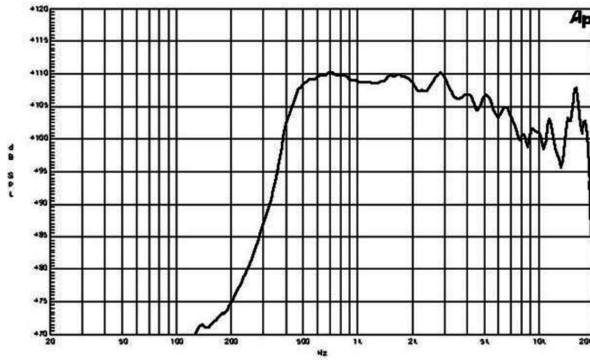

SPECIFICATIONS¹

Throat Diameter	50 mm (2.0 in)
Nominal Impedance	8 Ω
Minimum Impedance	8.2 Ω
Nominal Power Handling ²	110 W
Continuous power handling ³	220 W
Sensitivity (1W/1m) ⁴	107.0 dB
Frequency Range	0.5 - 18.0 kHz
Recommended Crossover ⁵	1.0 kHz
Voice Coil Diameter	75 mm (3.0 in)
Winding Material	Aluminium
Inductance	0.14 mH
Diaphragm Material	Titanium
Flux Density	1.8 T
Magnet Material	Ferrite

MOUNTING AND SHIPPING INFO

Four M6 holes 90° on 102 mm (4 in) diameter	
Overall Diameter	170 mm (6.7 in)
Depth	64 mm (2.5 in)
Net Weight	4.4 kg (9.7 lb)
Shipping Units	1
Shipping Weight	4.52 kg (9.96 lb)
Shipping Box	190x190x80 mm (7.48x7.48x3.15 in)
Other Details	4x M6 Mounting Studs with bolts and washers included

SERVICE KIT

Replacement diaphragm	MMD3ATN8
-----------------------	----------

1. Driver mounted on B&C ME 75 horn.
2. 2 hour test made with continuous pink noise signal within the range from the recommended crossover frequency to 20 kHz. Power calculated on rated minimum impedance.
3. Power on Continuous Program is defined as 3 dB greater than the Nominal rating.
4. Applied RMS Voltage is set to 2.83 V for 8 ohms Nominal Impedance.
5. 12 dB/oct. or higher slope high-pass filter.