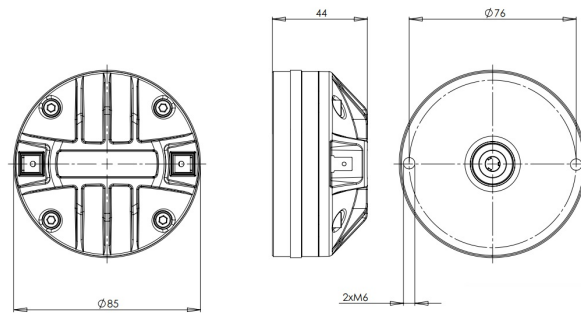

DE400TN

8Ω**HF Drivers - 1.0 Inches**

- 100 W continuous program power capacity
- 1" horn throat diameter
- 44 mm (1.7 in) aluminium voice coil
- Titanium diaphragm
- 1200 - 18000 Hz response
- 106 dB sensitivity
- Compact Neodymium magnet assembly
- Shorting copper cap for extended HF response

DE400TN

HF Drivers- 1.0 Inches

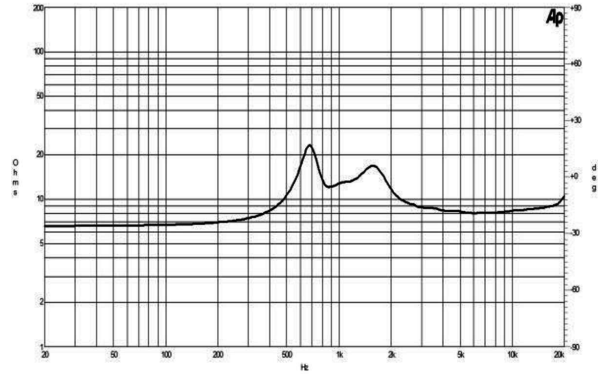
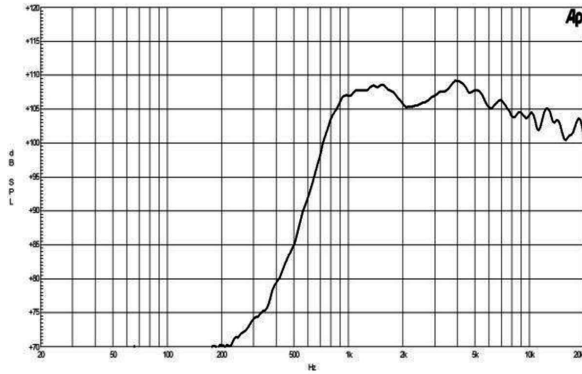

SPECIFICATIONS¹

Throat Diameter	25 mm (1.0 in)
Nominal Impedance	8 Ω
Minimum Impedance	7.7 Ω
Nominal Power Handling ²	50 W
Continuous Power Handling ³	100 W
Sensitivity (1W/1m) ⁴	106.0 dB
Frequency Range	1.2 - 18.0 kHz
Recommended Crossover ⁵	1.5 kHz
Voice Coil Diameter	44 mm (1.7 in)
Winding Material	Aluminium
Inductance	0.11 mH
Diaphragm Material	Titanium
Flux Density	1.8 T
Magnet Material	Neodymium Ring

MOUNTING AND SHIPPING INFO

Two M6 holes 180° on 76 mm (3 in) diameter	
Overall Diameter	85 mm (3.3 in)
Depth	44 mm (1.7 in)
Net Weight	0.8 kg (1.8 lb)
Shipping Units	1
Shipping Weight	0.83 kg (1.82 lb)
Shipping Box	105x105x65 mm (4.13x4.13x2.56 in)
Other Details	2x M6 Mounting Studs with bolts and washers included

SERVICE KIT

Replacement diaphragm	MMD400TN8
-----------------------	-----------

1. Driver mounted on B&C ME 45 horn.
2. 2 hour test made with continuous pink noise signal within the range from the recommended crossover frequency to 20 kHz. Power calculated on rated minimum impedance.
3. Power on Continuous Program is defined as 3 dB greater than the Nominal rating.
4. Applied RMS Voltage is set to 2.83 V for 8 ohms Nominal Impedance.
5. 12 dB/oct. or higher slope high-pass filter.